

INSTALLATION INSTRUCTIONS



UNLEASH.

THE SMARTEST PERFORMANCE TUNING TECHNOLOGY

QS4 USB STANDALONE QUICK SHIFT

**YAMAHA YZF R3A | 2015
Q748**

1>READ

WARNINGS > INSTALLING



- We strongly suggest that an experienced technician install this product.
- Read through all instructions before beginning installation.
- This document is intended for use by qualified technicians.
- This is not a replacement for the factory Engine Control Unit (ECU).
- Refer to a factory service manual for more specific stock component identification/location information and removal/assembly procedures.

WARNINGS > USING



- Use only in race or other closed-course applications and never on public roads.
- Z-Fi products are not certified by the California Air Resource Board (CARB) for use on CA highways.

GETTING HELP



- Factory support is available in the US at 909-597-8300.
- For fastest support outside of the US, find your local importer at bazzaz.net.

2>IDENTIFY

INCLUDED PARTS

1. QS4 USB control unit
2. QS4 harness
3. Shift Switch and mounting hardware
4. Scotchlok (3)
5. USB cable
6. Swingarm stickers
7. Velcro
8. Download Bazzaz software from bazzaz.net/index.php/software-overview

QS4 HARNESS

1. Main
2. +12v SW Power
3. Shift Switch
4. Ground
5. Speed
6. Left Coil
7. Right Coil

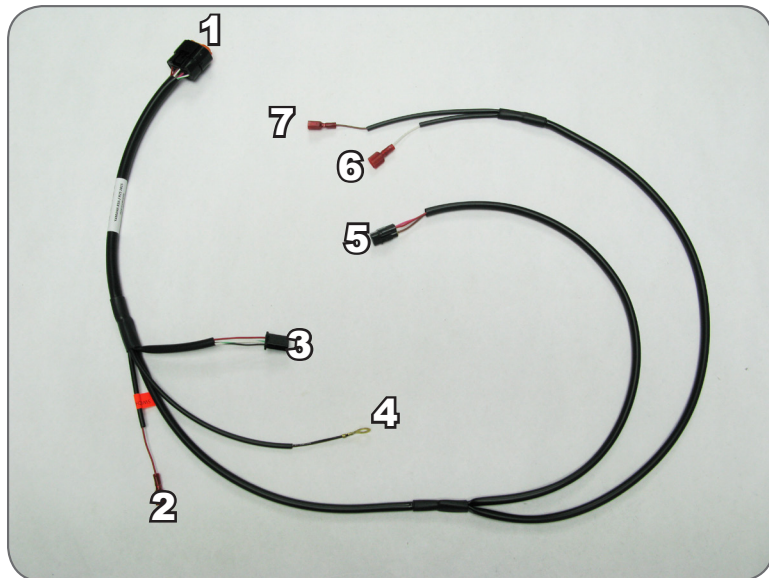

3>REMOVE

1. Rider seat
2. Passenger Seat
3. Right and left black side fairing
4. Fuel Tank
5. Fuel Tank Cover

4>SECURE

1. Mount the Bazzaz control unit using the supplied Velcro in the tail section of the bike.
2. Route the Bazzaz harness beneath the plastic tray and connect the Bazzaz harness to the control unit. Begin to route the harness towards the motor along the side frame rail.

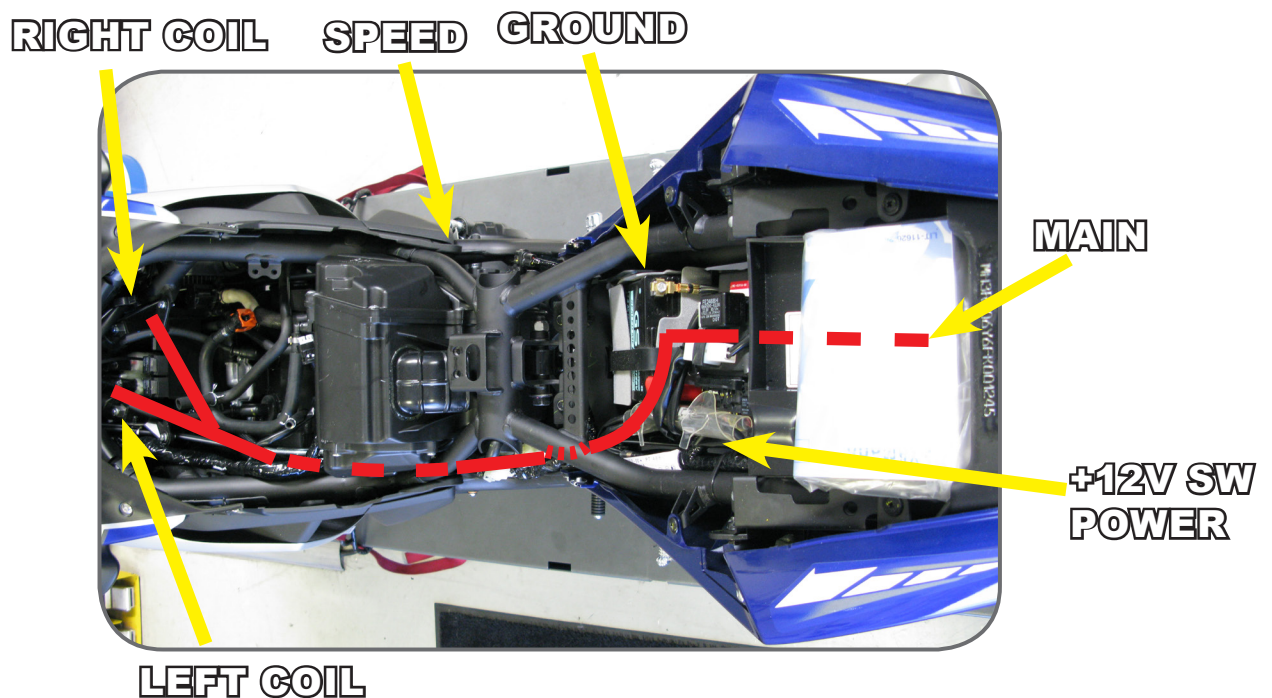

5>CONNECT

5.1

1. Route the Bazzaz speed sensor connector beneath the factory airbox and to the right hand side of the bike.
2. Locate the factory speed sensor connector to the right of the starter motor.
3. Disconnect the factory speed sensor connector and install the Bazzaz speed sensor connectors inline.

5>CONNECT (CONT.)

5.2

1. Connect the Bazzaz coil harness to the Bazzaz control unit, and begin to route the harness along the Bazzaz fuel harness towards the front of the bike.
2. Locate the factory left coil, and separate the factory orange wire.
3. Use the supplied scotchlok to crimp onto the orange wire, and connect the Bazzaz left coil connector.

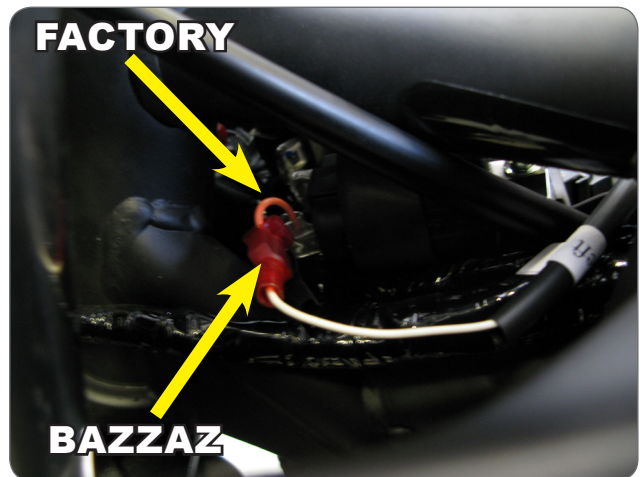

5.3

1. Locate the factory right coil connector.
2. Separate the factory red/grey wire, and use the supplied scotchlok to crimp onto the red/grey wire.
3. Connect the Bazzaz right coil connector.

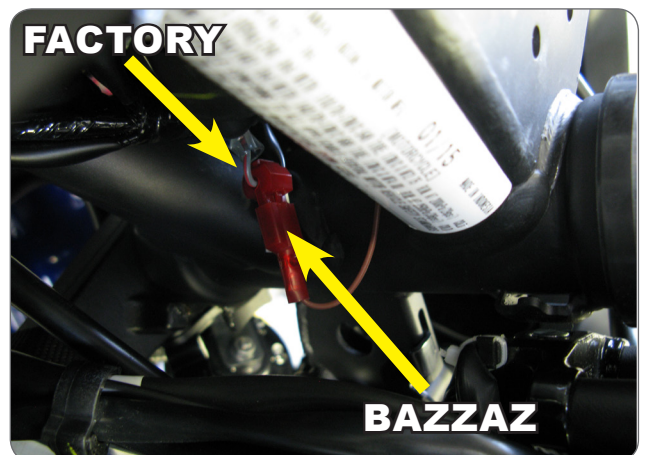

5.4

1. Locate the Bazzaz 12v SW power connector, and begin to route it towards the white factory three pin connector, which can be found on the left hand side of the bike.
2. Separate the factory blue wire, and use the supplied scotchlok to crimp onto the blue wire.
3. Connect the Bazzaz 12v SW power connector.

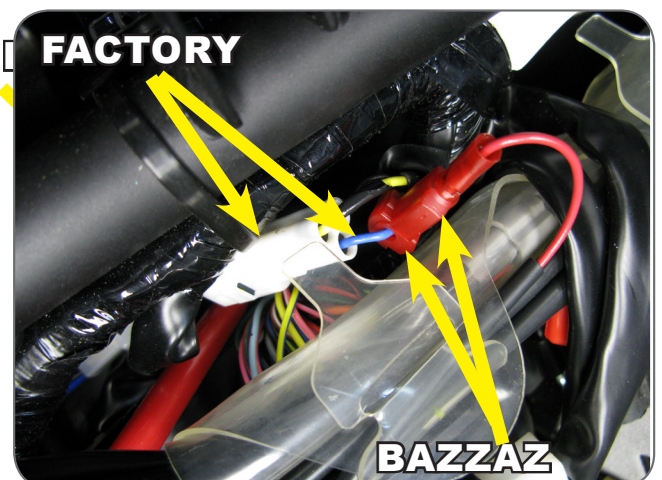

5>CONNECT (CONT.)

5.5

1. Locate the Bazzaz ground lug, and connect it to the negative battery terminal.

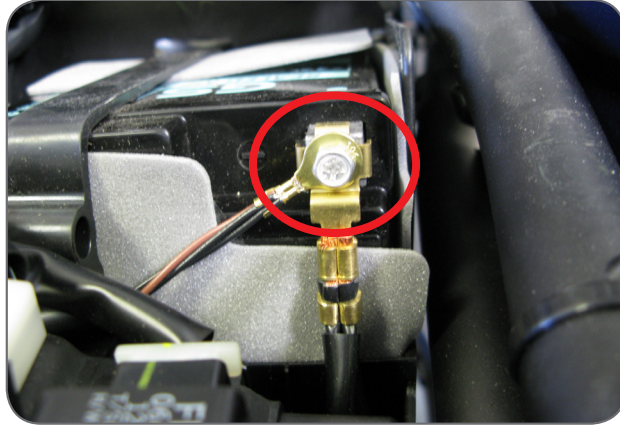

6>QUICKSHIFT

1. Measure and note your shift pedal height, so that you may reposition the shift pedal once complete.
2. Remove the factory shift rod and begin to install the Bazzaz shift switch using one of the supplied allen stud bolts and tighten.
3. Next begin to install the Bazzaz shift rod. The shift rod may need to be cut to get your original shift pedal height.
4. Ensure to retighten all lock nuts on the shift linkage.

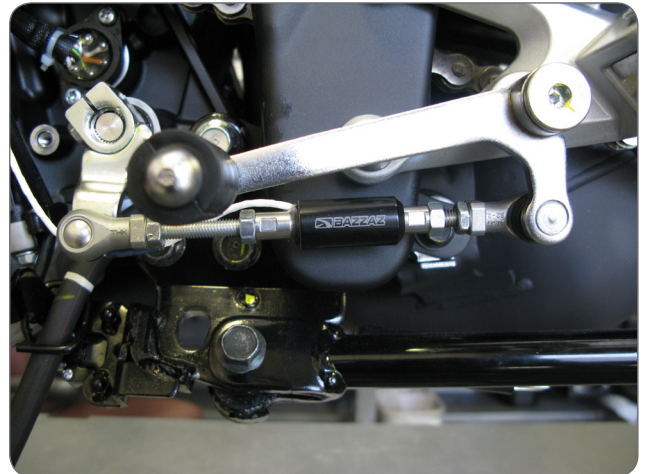

7>SECURE



Use the supplied cable ties to secure the harness neatly along the routing path **free of any moving or hot components** (which could cause damage or failure of the system).

8>CHECK



1. In order to check that the system is installed correctly, download the Bazzaz Z-Fi Mapper software at bazzaz.net.
2. Plug the USB cable into the control unit and computer.
3. Locate and open the Z-Fi Mapper software.
4. Check that the pre-programmed settings match the model of your bike in the “comment” field within the software.
5. Start the vehicle and begin to check that the following inputs read correctly on the fuel map page.
 - RPM - Make sure that the RPM is reading near what the vehicle is idling at.
 - GPS - The vehicle should read neutral (or whichever gear it is in). For motorcycles that use a Gear Position Sensor, the bike does not need to be running to do this. For motorcycles that use a speed sensor, the wheel must be spinning to read gear properly. This can be checked on a dynamometer or by using a rear stand. Use caution when testing componentry.
 - TPS - When throttle is applied, the TPS should read accordingly. Fly-by-wire models must be running to check TPS. Normal cable operated throttles can be checked with just the key on, not running.

Also use software to:

- View and/or make adjustments to fuel maps
- Activate Z-AFM self mapper (sold separately)
- Save and load new fuel maps
- Re-calibrate throttle position sensor after throttle modifications
- View diagnostics for troubleshooting
- Change quickshift settings
- Make traction control adjustments



If any problem is found, please carefully follow through the installation steps again.



If problem still persists, please contact Bazzaz tech support

- Factory support is available in the US at 909-597-8300.
- For fastest support outside of the US, find your local importer at bazzaz.net

9>REINSTALL

After it is determined that everything is correct, reinstall the components removed in step 3.

10>NEXT LEVEL

SHIFT LIGHT (Sold Separately)

Illuminates white to identify pre-determined, optimal shift points.

Used to improve forward drive and momentum for faster drag passes and lap times.

Comes pre-programmed with suggested values that can be easily adjusted as desired.

*For use with the QS4 USB stand-alone quick shift only.

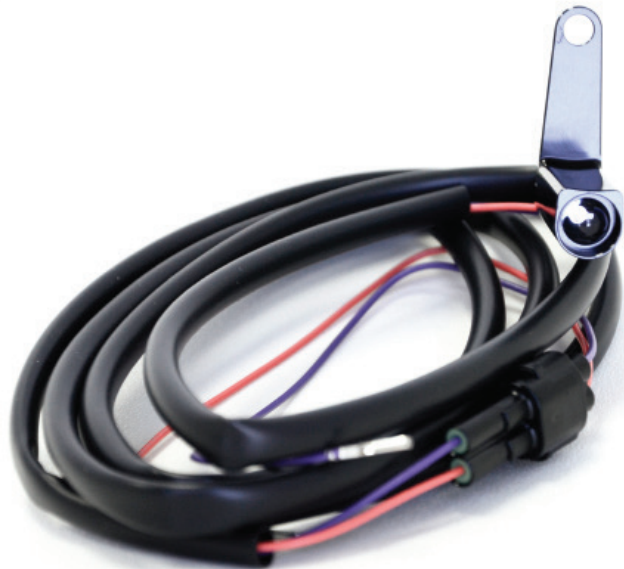

\$129.99



THE SMARTEST PERFORMANCE TUNING TECHNOLOGY



Proudly made in the
United States

Q748